

## Scheda prodotto

**REF: 142 273**

**Broche (gancio) in plastica universale doppia mm. 200 nera con frontale arrotondato per porta etichette**

Broche (gancio) universale doppia in plastica nera mm. 200 con frontale arrotondato per porta etichette.

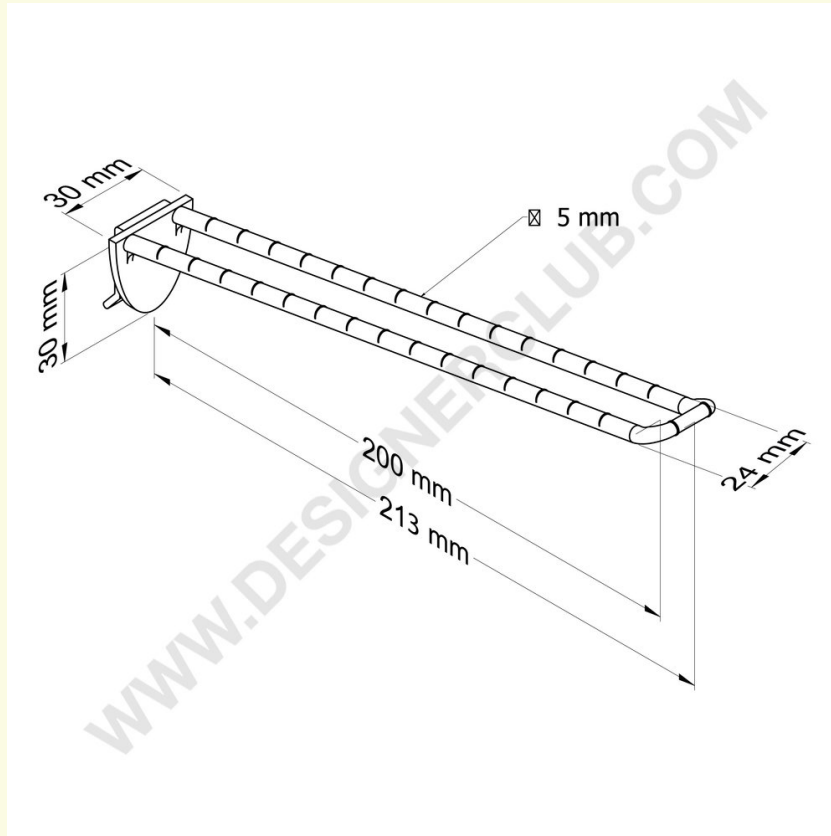

+39 0332 455 360      [www.designerclub.com](http://www.designerclub.com)      [commerciale@designerclub.com](mailto:commerciale@designerclub.com)  
Designer Club S.R.L. Via 2 Giugno 28, 21022, Azzate (VA) , Italy