

Datasheet

REF: 113 210

Half sphere stand Ø 400 mm with sign holder and base Ø 300 mm - Easy

Half sphere stand Ø 400 mm with sign holder A4 - Easy.

Base Ø 300 mm, Height pole 750 mm.

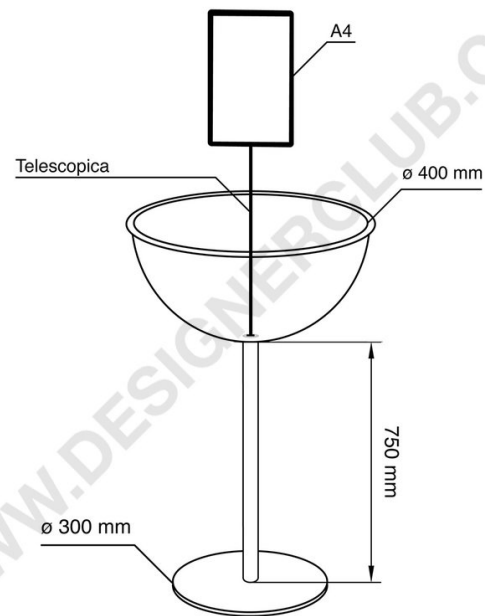

+39 0332 455 360 www.designerclub.com commerciale@designerclub.com
Designer Club S.R.L. Via 2 Giugno 28, 21022, Azzate (VA) , Italy