

Datasheet

REF: 113 207

Stojak półkulisty Ø 500 mm z uchwytem na znak i podstawą Ø 350 mm - Easy

Półkulisty stojak Ø 500 mm z uchwytem na szyld A4 - Easy.

Podstawa Ø 350 mm, słupek wysokości 750 mm.

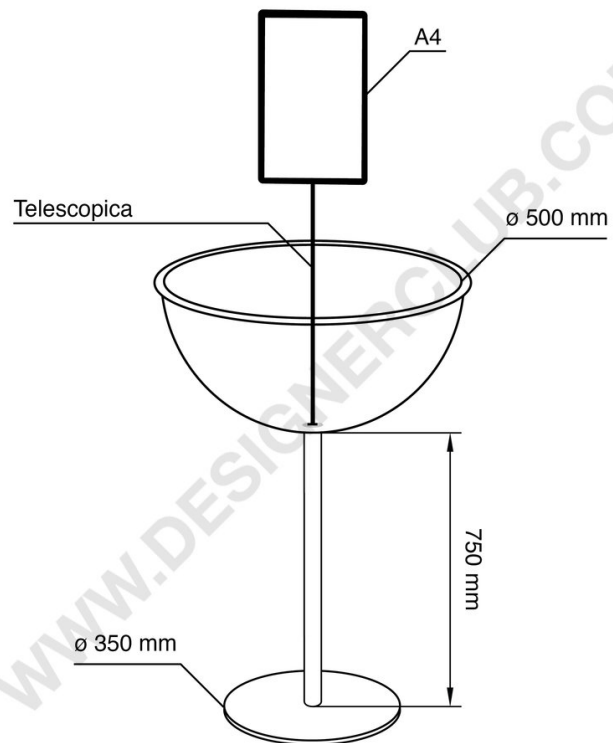

+39 0332 455 360 www.designerclub.com commerciale@designerclub.com
Designer Club S.R.L. Via 2 Giugno 28, 21022, Azzate (VA), Italy