

Scheda prodotto

REF: 111 778

Broche (gancio) in plastica singola bianca ins. automatico lungh. mm. 50

Broche (gancio) singola ad inserimento automatico in plastica bianca mm. 50.

Colore nero: ref. 111 784.

Colore trasparente: ref. 113 126.

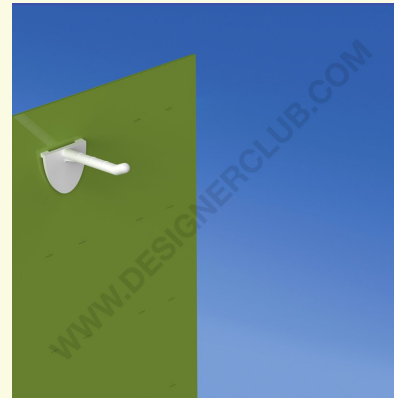
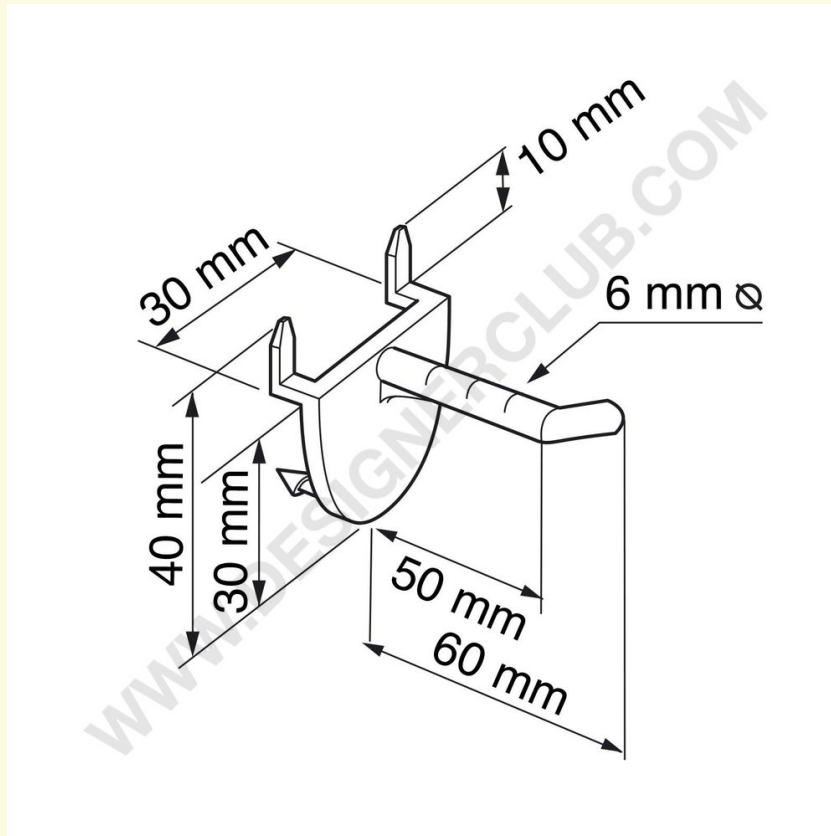

+39 0332 455 360

www.designerclub.com

commerciale@designerclub.com

Designer Club S.R.L. Via 2 Giugno 28, 21022, Azzate (VA), Italy