

Scheda prodotto

REF: 144 163

Broche (gancio) in plastica universale doppia mm. 200 bianca per spessore mm. 16 p. e. lungo

Broche (gancio) universale doppia in plastica bianca mm. 200 per spessore mm. 16 con attacco per porta etichette lungo (porta etichette fornito a parte su richiesta).

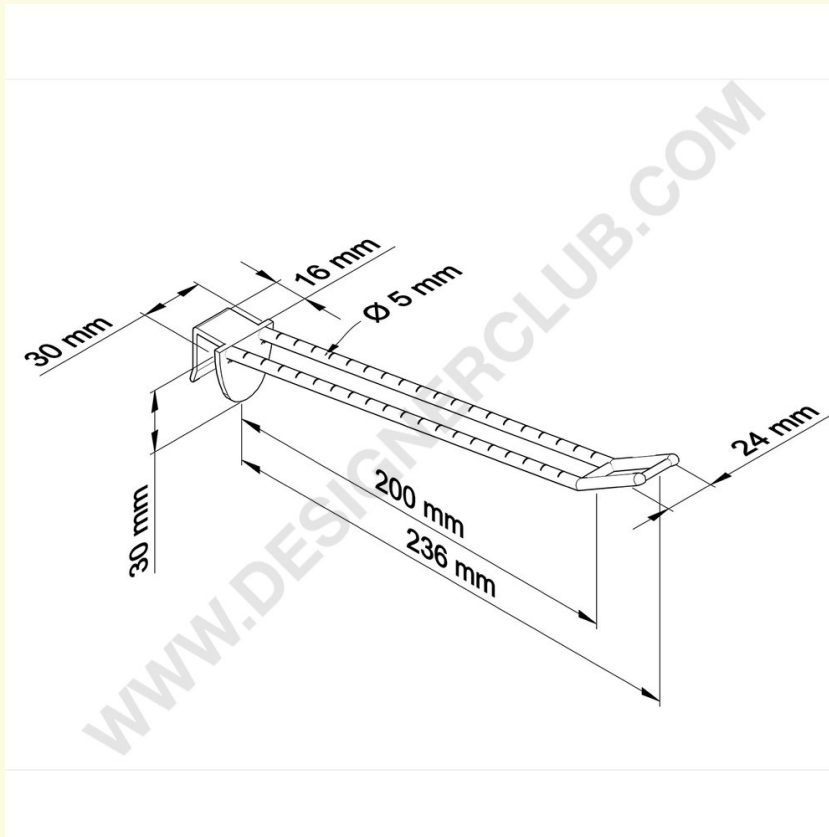

+39 0332 455 360 www.designerclub.com commerciale@designerclub.com
Designer Club S.R.L. Via 2 Giugno 28, 21022, Azzate (VA), Italy