

Fiche technique

REF: 111 939

Aimant rectangulaire 20x10 mm. - épaisseur 2 mm.

Aimant rectangulaire dimensions: 20x10 mm, épaisseur 2 mm, en acier galvanisé.

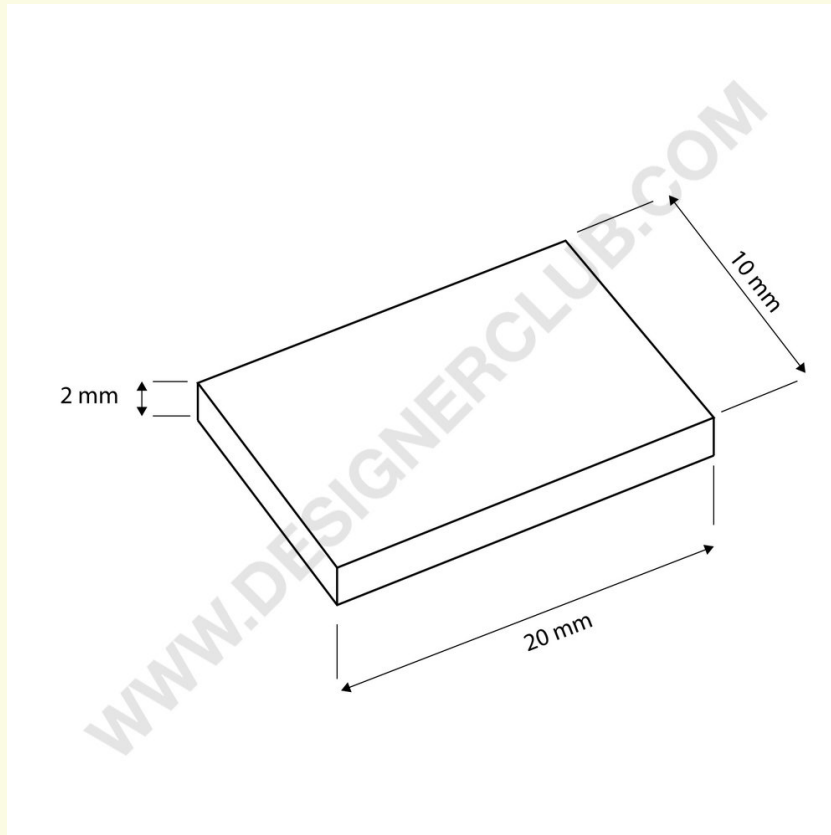

+39 0332 455 360 www.designerclub.com commerciale@designerclub.com
Designer Club S.R.L. Via 2 Giugno 28, 21022, Azzate (VA), Italy