

Gegevensblad

REF: 111 731

Dubbele tand stierenhorens haak mm. 200

Dubbele metalen haak voor wasbord. Lengte mm. 200 - mm. 50 gaatjes.

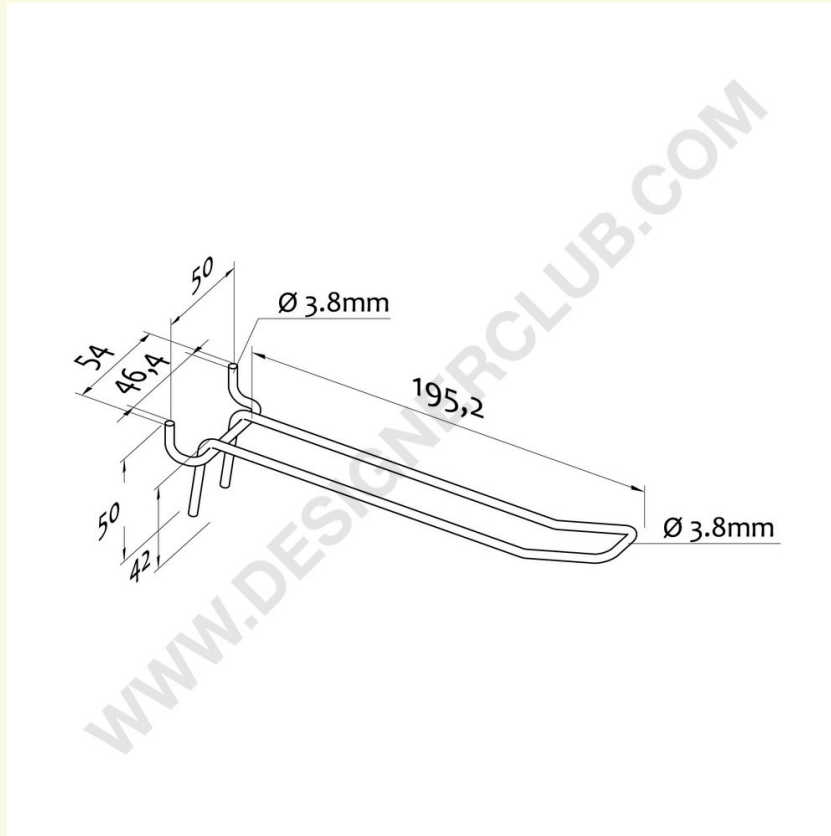

+39 0332 455 360 www.designerclub.com commerciale@designerclub.com
Designer Club S.R.L. Via 2 Giugno 28, 21022, Azzate (VA), Italy